

İSİLDAR
LIGHTING SYSTEM

2024/1 FİYAT LİSTESİ

www.isildar.eu

İŞILDAR

LIGHTING SYSTEM

İşıldar Aydınlatma Metin BODUR tarafından 1972 yılında İstanbul'da kurulmuştur.

250m2 kapalı alanda kalıp atölyesini kurarak plastik elektrik malzemeleri imalatına başlamıştır. 2004 yılında değişen görüşleri doğrultusunda; hayat verdiği tasarımları ile aydınlık mekanlar yaratmaya İkitelli Organize Sanayide kurulmuş olup, şu anda kendi yerinde 16.000 m² kapalı alanda üretime devam etmektedir. Makine parkurunu ve ürün çeşitlerini yenileyerek markalaşmayı da hedef alarak profesyonel Satış ve Pazarlama ekibini kurmuştur. Üretimini yüzde 50'sini iç pazar, yüzde 50'sini dış pazar oluşturmaktadır.

47 ülkeye ihracatıyla dış pazarda da adını duyuran firmamız, geleceğin global ölçekli firmalarından biri olmayı hedefleyip müşterilerinin aydınlatma firmasından beklediği profesyonel hizmeti, satış ve satış sonrasında da sağlayabilmek için dinamik yapısını hiç bitmeyen enerjisiyle canlı tutmaktadır.

Sektördeki kalıcılığımızı kalite standartlarımızın yükselen grafiği ile müşterilerimizle kurduğumuz karşılıklı güvene dayalı ilişkinin sarsılmaz temeline borçluyuz.

Neden İŞILDAR?

Müşterilerimizin beklentilerini karşılayan, aydınlatma tekniğinin en güvenilir şekilde hayata geçirildiği, çevre dostu, kaliteli aydınlatma ürünlerini geliştirirken ve üretirken, kalite yönetim sistemimizin sürekli iyileştirilmesini, çalışanların yetkinliklerini arttırıp, katılımcı olmalarını, verimliliği arttırarak rekabetçi kalabilmeyi esas alırız.

Nasıl Çözeriz?

İşıldar Aydınlatma olarak;

Yükselen başarı grafiğimizi devam ettirerek akla gelen ilk aydınlatma markası olmayı hedefleyerek, enerji tasarrufunu ön planda tutan ürünler üreterek ülke ekonomisine katkı sağlamayı amaçlayarak, müşteri ihtiyaçlarına yönelik kaliteli Ürünler üreterek kalitemizi ve güvenilirliğimizi yükselen grafiğimizle birlikte daha da ön plana çıkararak müşterilerimizin ihtiyaçlarına çözüm odaklı yaklaşım politikamızla yürümeye devam edeceğiz.

www.isildar.eu

İÇİNDEKİLER

02	PRİZ GRUBU
12	ASPIRATÖRLER
13	SİGORTA KUTULARI VE KLEMENSLERİ
14	POLİKARBON PANO VE TERMOPLASTİK BUATLAR
15	KOMBİNASYON KUTULARI VE MAKİNE PRİZLERİ
16	TERMOPLASTİK, SIVA ÜSTÜ ANTİGRON VE KARA BUATLAR
17	KASA, BUATLAR VE BUAT KAPAKLARI
18	KABLO BAĞLARI
20	GEÇMELİ, MANDALLI, PLASTİK KLEMENSLER
21	ÇİVİLİ, PLASTİK ANTİGRON KROŞELER VE DUYLAR
22	PLASTİK DÜBELLER
23	YENİ NESİL LED'Lİ ÜRÜNLER
24	KAPALI DUVAR APLİKLER
26	AÇIK DUVAR APLİKLER
27	GLOP ARMATÜRLER
32	NEMLİ YER ARMATÜRLERİ (POLİKARBON)
36	SAÇ TABANLI VE CAM ARMATÜRLER
37	SARKIT ARMATÜRLER
38	BAHÇE ARMATÜRLER
40	SENSÖRLÜ TAVAN VE DUVAR ARMATÜRLERİ
44	ACİL AYDINLATMA VE YÖNLENDİRME LEVHALARI
45	ETANJ BANT ARMATÜRLER
47	YÜKSEK TAVAN ARMATÜRLER
48	TMS ARMATÜRLER
49	BANT ARMATÜRLER
50	BACKLIGHT ARMATÜRLER
54	ÇERÇEVELER

ISILDAR®

LIGHTING SYSTEM



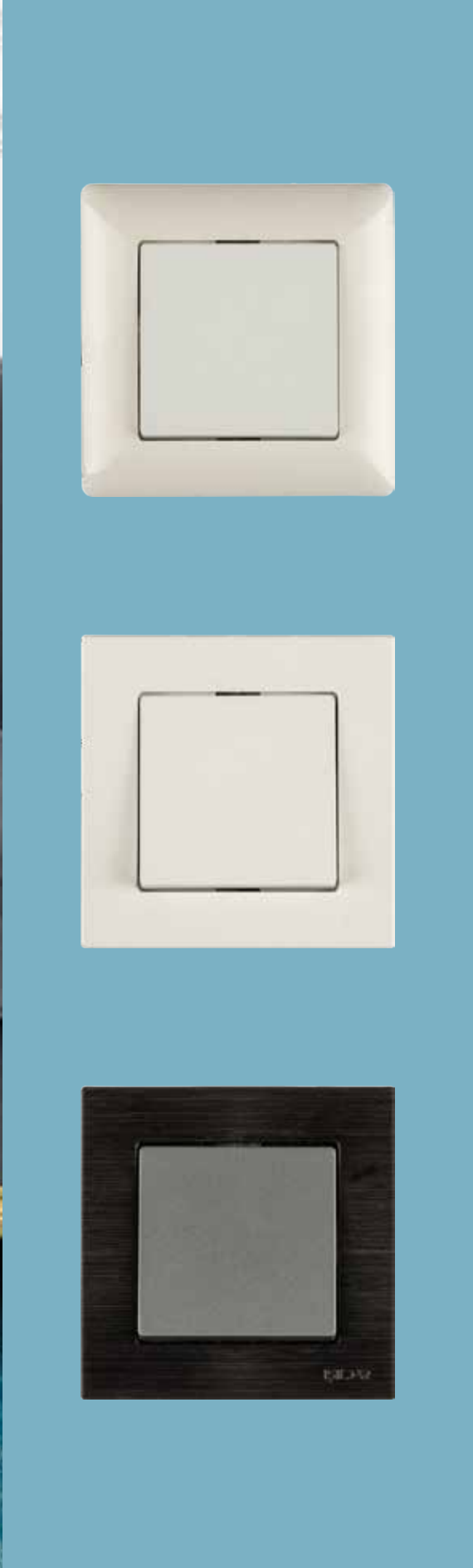

A SERİSİ

C SERİSİ

E SERİSİ

ISIDAR
LIGHTING SYSTEM

GREEN ENERGY



A SERİSİ

Beyaz / White



Metalik Gri / Metallic Gray

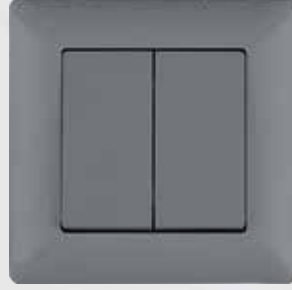

Metalik Siyah / Metallic Black



Krem / Cream



Metalik Kahve / Metallic Brown



Anahtar / Switch



Komütatör / Double One Way Switch



Topraklı Priz / Earthed Socket Outlet

Çerçeveler/Frames



İSİLDAR
LIGHTING SYSTEM



Her Mekana Uyumlu
İşlevsel Tasarımlar...

*Compatible with Every Place
Functional Designs...*



C SERİSİ

Beyaz / White



Metalik Kahve / Metallic Brown



Metalik Siyah / Metallic Black



Krem / Cream

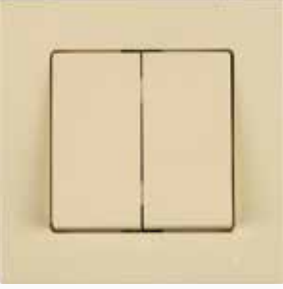

Metalik Gri / Metallic Gray



Anahtar / Switch



Komütatör / Double One Way Switch



Topraklı Priz / Earthed Socket Outlet

Çerçeveler/Frames

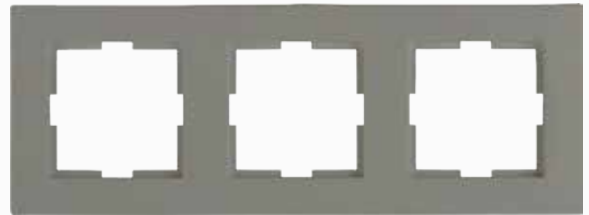
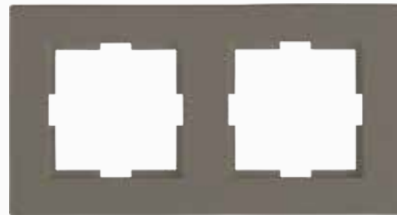

İŞİDAR
LIGHTING SYSTEM



Şık Ve Zarif
Tasarımlar...

*Stylish and Elegant
Designs.*



E SERİSİ

Metalik Gri / Metallic Gray



Metalik Siyah / Metallic Black



Metalik Kahve / Metallic Brown



Anahtar / Switch

Topraklı Priz / Earthed Socket Outlet

Çerçeveler/Frames

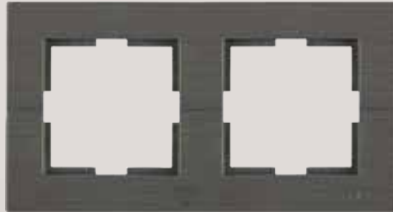



ISILDAR[®]
LIGHTING SYSTEM

DiĐER ÜRÜNLERİMİZ

www.isildar.eu

Sıva Üstü Sigorta Kutuları





Kod	Ürün Adı	Amb. Ad.	Koli Ad.	Fiyat (₺)
22 000 000 110 2000	1'li Sıva Üstü	30	360	21,00
22 000 000 210 2001	1-2'li Sıva Üstü	20	240	28,00
22 000 000 310 2002	3-4'lü Sıva Üstü	10	120	42,00

Sıva Altı Sigorta Kutuları (Klemenssiz)





Kod	Ürün Adı	Amb. Ad.	Koli Ad.	Fiyat (₺)
14 000 000 210 2011	2'li Sıva Altı	1	48	89,00
14 000 000 610 2013	2-6'lı Sıva Altı	1	36	139,00
14 000 000 910 2015	9'lu Sıva Altı	1	24	159,00
14 000 001 210 2017	12'li Sıva Altı	1	24	225,00
14 000 001 610 2023	16'lı Sıva Altı / TEK SIRA	1	16	285,00
14 000 001 610 2019	16'lı Sıva Altı	1	12	285,00
14 000 002 410 2021	24'lü Sıva Altı	1	10	365,00

Sıva Üstü Sigorta Kutuları (Klemenssiz)





Kod	Ürün Adı	Amb. Ad.	Koli Ad.	Fiyat (₺)
24 000 000 210 2012	2'li Sıva Üstü	1	48	99,00
24 000 000 610 2014	2-6'lı Sıva Üstü	1	36	149,00
24 000 000 910 2016	9'lu Sıva Üstü	1	24	199,00
24 000 001 210 2018	12'li Sıva Üstü	1	24	257,00
24 000 001 610 2024	16'lı Sıva Üstü TEK SIRA	1	16	309,00
24 000 001 610 2020	16'lı Sıva Üstü	1	12	309,00
24 000 002 410 2022	24'lü Sıva Üstü	1	10	399,00

Sıva Altı Saç Tabanlı Sigorta Kutuları (Klemenssiz)



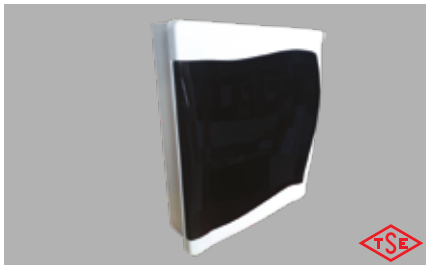

Kod	Ürün Adı	Amb. Ad.	Koli Ad.	Fiyat (₺)
14 000 001 210 2027	12'li Sıva Altı	1	24	499,00
14 000 001 610 2029	16'lı Tek Sıra Sıva Altı	1	16	629,00
14 000 001 610 2031	16'lı Çift Sıra Sıva Altı	1	12	629,00
14 000 002 410 2025	24'lü Sıva Altı	1	12	679,00
14 000 003 610 2041	36'lı Sıva Altı	1	12	949,00
14 000 004 810 2042	48'li Sıva Altı	1	12	2.169,00

Sıva Altı Zayıf Akım Kutuları (Klemenssiz)



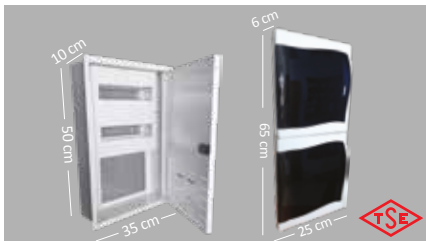

Kod	Ürün Adı	Amb. Ad.	Koli Ad.	Fiyat (₺)
14 000 004 810 2033	48'li Sıva Altı Saç tabanlı+plastik kapaklı zayıf akım kutusu	1	6	3.699,00
14 000 004 810 2035	48'li Sıva altı Saç tabanlı+saç kapaklı zayıf akım kutusu	1	6	3.899,00

Sigorta Kutusu Klemensleri



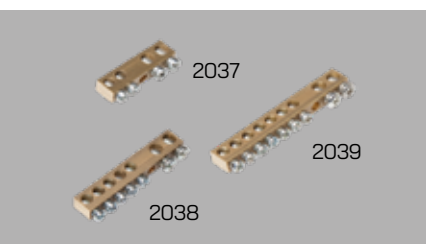

Kod	Ürün Adı	Amb. Ad.	Koli Ad.	Fiyat (₺)
90 000 000 000 2037	4 Delikli (2-6'lı Sigorta Kutusu İçin)	30	24	29,00
90 000 000 000 2038	7 Delikli (9-16'lı Sigorta Kutusu İçin)	20	16	55,00
90 000 000 000 2039	9 Delikli (12-24'lü Sigorta Kutusu İçin)	10	12	72,00

■ Polikarbon Dağıtım Panoları

HF
IP54



Kod	Ürün Adı	Amb. Ad.	Koli Ad.	Fiyat (₺)
45 400 223 030 2230	22X30X15 Polikarbon Etanj Pano	1	12	469,00
45 400 223 330 2233	22X30X15 Polikarbon Etanj Pano (Şeffaf Kapak)	1	12	535,00
46 500 304 030 2231	30X40X15 Polikarbon Etanj Pano	1	6	819,00
46 500 304 030 2232	30X40X15 Polikarbon Etanj Pano (Şeffaf Kapak)	1	6	1.079,00
46 500 355 030 2234	35X50X17 Polikarbon Etanj Pano	1	4	1.249,00
46 500 355 030 2235	35X50X17 Polikarbon Etanj Pano (Şeffaf Kapak)	1	4	1.359,00
46 500 406 030 2236	40X60X20 Polikarbon Etanj Pano	1	2	1.599,00
46 500 406 030 2237	40X60X20 Polikarbon Etanj Pano (Şeffaf Kapak)	1	2	1.799,00
46 500 507 030 2240	50X70X22 Polikarbon Etanj Pano	1	1	4.199,00

120x205 1'li Kombinasyon Kutuları

HF
HALDOR
PRİZ
IP54

Kod	Ürün Adı	Amb. Ad.	Koli Ad.	Fiyat (₺)
35 400 122 030 2214	120X205 1'Lİ (Boş)	1	20	199,00
35 401 122 030 2215	1'li (1 Adet 3X25 A. Trifaze + 2 Adet 1X16 A. Monofaze Priz)	1	20	449,00
35 402 122 030 2216	1'li (1 Adet 5X16 A. Trifaze + 2 Adet 1X16 A. Monofaze Priz)	1	20	659,00
35 403 122 030 2217	1'li (1 Adet 5X32 A. Trifaze + 2 Adet 1X16 A. Monofaze Priz)	1	20	739,00

180x270 2'li Kombinasyon Kutuları

HF
HALDOR
PRİZ
IP54

Kod	Ürün Adı	Amb. Ad.	Koli Ad.	Fiyat (₺)
35 400 182 730 2218	180X270 2'Lİ (Boş)	1	12	329,00
35 406 182 730 2219	2'li (2 Adet 3X25 A. Trifaze + 2 Adet 1X16 A. Monofaze Priz)	1	12	769,00
35 407 182 730 2225	2'li (2 Adet 3X25 A. Trifaze + 4 Adet 1X16 A. Monofaze Priz)	1	12	899,00
35 408 182 730 2220	2'li (2 Adet 5X16 A. Trifaze + 2 Adet 1X16 A. Monofaze Priz)	1	12	1.199,00
35 403 182 730 2221	2'li (2 Adet 5X32 A. Trifaze + 2 Adet 1X16 A. Monofaze Priz)	1	12	1.299,00
35 404 182 730 2222	2'li (1 Adet 3X25 A. Trifaze + 1 Adet 5X16 A. Trifaze + 2 Adet Monofaze Priz)	1	12	1.199,00

Makine Prizleri

HF
HALDOR
PRİZ

Kod	Ürün Adı	Amb. Ad.	Koli Ad.	Fiyat (₺)
90 000 000 000 2250	1X16 A. Monofaze Priz	1	6	59,00
90 000 000 000 2251	3X25 A. Trifaze Priz	1	6	149,00

3'lü Kapaklı Kauçuk Monofaze Grup Priz

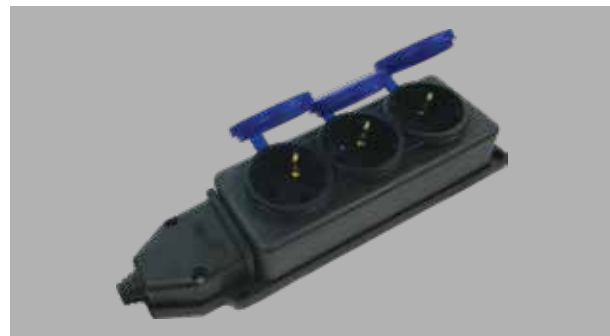
HF
HALDOR
PRİZ

Kod	90 000 000 000 2252
Ürün Adı	3'lü Kauçuk Monofaze Grup Priz
Ambalaj Adedi	12
Koli Adedi	48
Fiyat (₺)	199,00

Termoplastik Buatlar

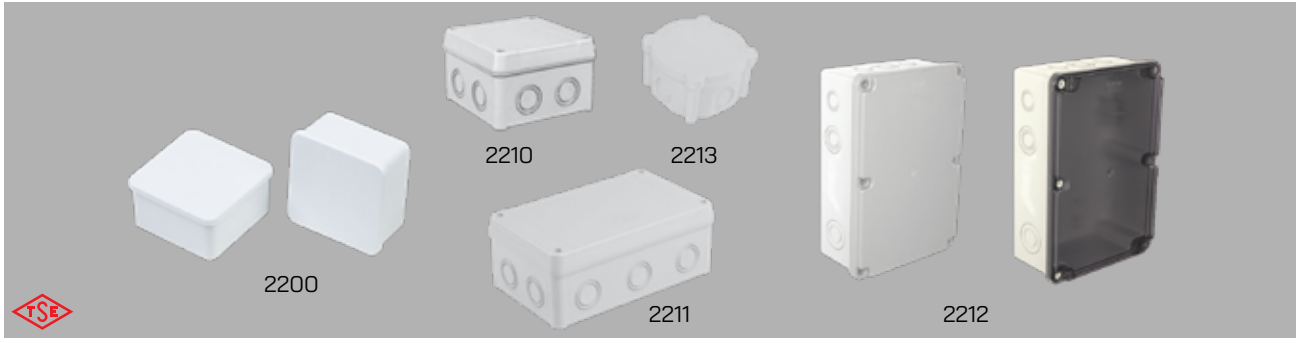
 HF
 IP54

Kod	Ürün Adı	Amb. Ad.	Koli Ad.	Fiyat (₺)
55 400 111 130 2210	110X110X70 8 Çıkışlı Contalı Termoplastik Buat	10	100	57,00
55 400 111 830 2211	110X180X70 10 Çıkışlı Contalı Termoplastik Buat	6	60	99,00
55 400 182 130 2212	180X270X100 14 Çıkışlı Contalı Termoplastik Buat	2	24	189,00
55 400 182 130 2223	180X270X100 14 Çıkışlı Contalı Termoplastik Buat (Şeffaf Kapaklı)	2	24	199,00
55 400 009 030 2213	Çap 90 4 Çıkışlı Termoplastik Buat	24	240	27,00
54 000 858 510 2200	85X85X48 Kare Antigron Buat	20	240	25,00

Sıva Üstü Antigron ve Kare Buatlar (Geçmeli Kapak) Siyah

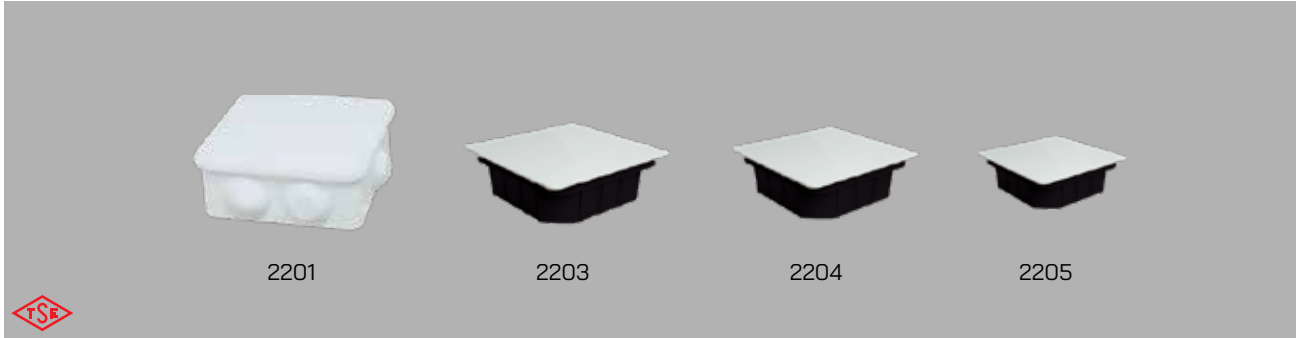
 HF
 IP40

Kod	Ürün Adı	Amb. Ad.	Koli Ad.	Fiyat (₺)
54 000 858 510 2201	85X85 Kare Antigron Buat (Beyaz)	20	240	21,00
52 000 101 020 2203	10X10 Kare Buat (Siyah)	15	180	27,00
52 000 131 320 2204	13X13 Kare Buat (Siyah)	25	150	39,00
52 000 202 020 2205	20X20 Kare Buat (Siyah)	10	60	71,00

Kare Buatlar (Geçmeli Kapak) Oranj

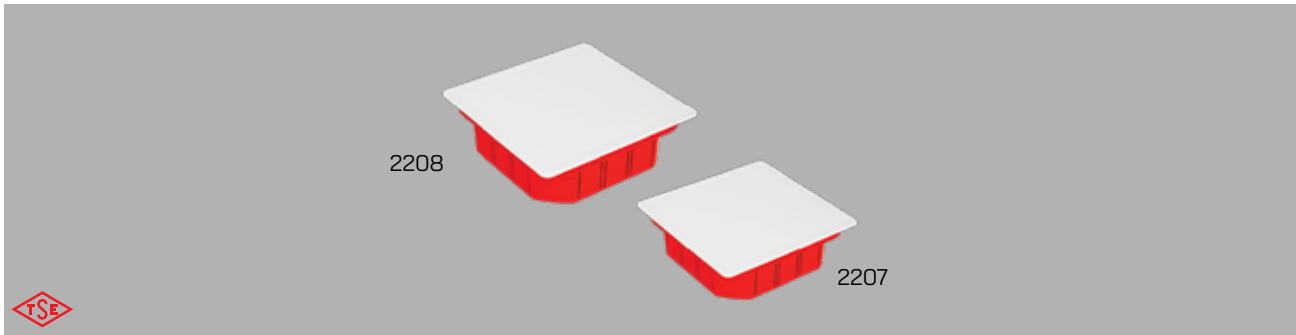
 HF
 IP40

Kod	Ürün Adı	Amb. Ad.	Koli Ad.	Fiyat (₺)
52 000 101 040 2207	10X10 Kare Buat (Oranj)	15	180	33,00
52 000 131 340 2208	13X13 Kare Buat (Oranj)	25	150	45,00
52 000 202 040 2209	20X20 Kare Buat (Oranj)	10	60	89,00

■ Kasa ve Buatlar Siyah



Kod	Ürün Adı	Amb. Ad.	Koli Ad.	Nak. Hariç (₺)	Nak. Dahil (₺)
52 000 000 020 1802	Geçmeli Plastik Derin Kasa Kapaksız	100	1000	3,90	4,50
52 000 000 020 1801	Geçmeli Plastik Derin Kasa Kapaklı	100	1000	6,50	7,50
52 000 000 020 1805	Geçmeli Alçıpan Kasa	100	600	12,00	13,80
52 000 000 020 1816	Norm Plastik Kasa	100	1000	5,70	6,60
52 000 000 020 1808	Norm Kapaksız Buat	100	600	5,70	6,60
52 000 000 020 1807	Norm Kapaklı Buat	100	600	7,90	9,10
52 000 000 020 1818	Norm 14-18 mm Girişli Plastik Takoz	100	600	6,50	7,50

■ Kasa ve Buatlar Oranj

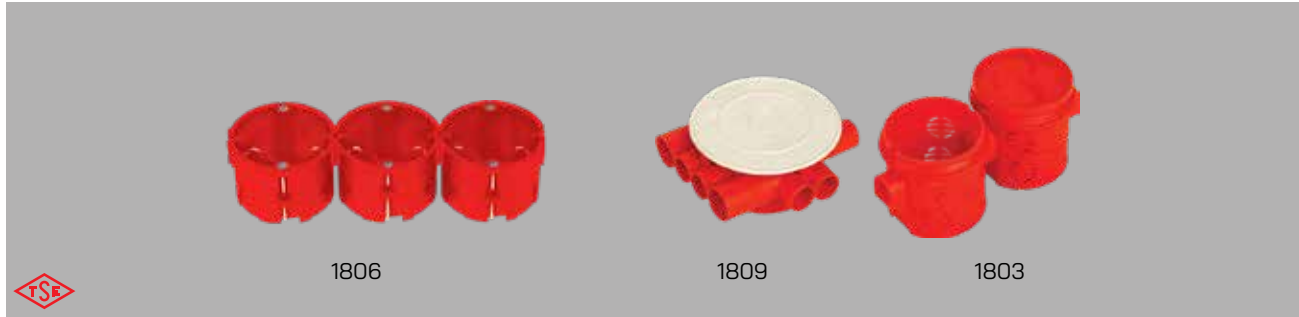

Kod	Ürün Adı	Amb. Ad.	Koli Ad.	Nak. Hariç (₺)	Nak. Dahil (₺)
52 000 000 040 1804	Geçmeli Plastik Derin Kasa Kapaksız	100	1000	7,70	8,90
52 000 000 040 1803	Geçmeli Plastik Derin Kasa Kapaklı	100	1000	8,90	10,30
52 000 000 040 1806	Geçmeli Alçıpan Kasa	100	600	15,50	17,80
52 000 000 040 1817	Norm Plastik Kasa	100	1000	8,00	9,20
52 000 000 040 1810	Norm Kapaksız Buat	100	600	11,00	12,70
52 000 000 040 1809	Norm Kapaklı Buat	100	600	13,00	15,00

■ Lüks Buat Kapakları



Kod	Ürün Adı	Amb. Ad.	Koli Ad.	Nak. Hariç (₺)	Nak. Dahil (₺)
52 000 000 010 2402	Çap 90 Bombeli Plastik Ayak	100	2000	3,90	4,50
52 000 000 010 2403	Çap 90 Vidalı Bombeli Plastik Ayak	100	2000	6,50	7,50
52 000 000 010 2404	Çap 120 Bombeli Plastik Ayak	100	1000	9,90	11,50

■ Kablo Bağları

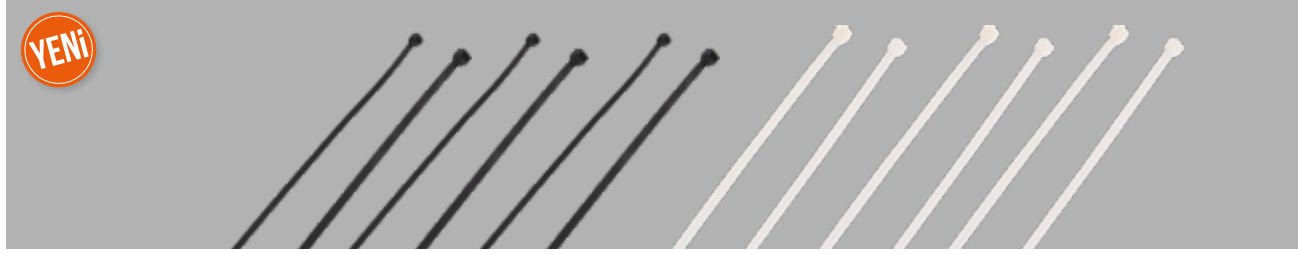

Kod	Renk	En	Boy	Poşet Ad.	Koli Ad.	Fiyat (₺)
90 000 000 000 1435	Beyaz	2,5	100	100	20000	0,21
90 000 000 000 1436	Beyaz	2,5	150	100	20000	0,35
90 000 000 000 1437	Beyaz	2,5	200	100	20000	0,49
90 000 000 000 1438	Beyaz	3,6	150	100	10000	0,62
90 000 000 000 1439	Beyaz	3,6	200	100	10000	0,79
90 000 000 000 1440	Beyaz	3,6	250	100	10000	0,95
90 000 000 000 1441	Beyaz	3,6	300	100	10000	1,2
90 000 000 000 1442	Beyaz	3,6	370	100	10000	1,53
90 000 000 000 1443	Beyaz	4,8	200	100	10000	1,1
90 000 000 000 1444	Beyaz	4,8	250	100	10000	1,39
90 000 000 000 1445	Beyaz	4,8	300	100	10000	1,68
90 000 000 000 1446	Beyaz	4,8	380	100	5000	1,95
90 000 000 000 1447	Beyaz	4,8	400	100	5000	2,25
90 000 000 000 1448	Beyaz	7,6	300	100	3000	3,7
90 000 000 000 1449	Beyaz	7,6	370	100	3000	3,95
90 000 000 000 1450	Beyaz	7,6	400	100	3000	4,5
90 000 000 000 1451	Beyaz	7,6	450	100	3000	4,5
90 000 000 000 1452	Beyaz	7,6	550	100	3000	5,9
90 000 000 000 1453	Beyaz	9	760	100	1000	9,9
90 000 000 000 1454	Beyaz	9	920	100	1000	14

Kod	Renk	En	Boy	Poşet Ad.	Koli Ad.	Fiyat (₺)
90 000 000 000 1460	Siyah	2,5	100	100	20000	0,21
90 000 000 000 1461	Siyah	2,5	150	100	20000	0,35
90 000 000 000 1462	Siyah	2,5	200	100	20000	0,49
90 000 000 000 1463	Siyah	3,6	150	100	10000	0,62
90 000 000 000 1464	Siyah	3,6	200	100	10000	0,79
90 000 000 000 1465	Siyah	3,6	250	100	10000	0,95
90 000 000 000 1466	Siyah	3,6	300	100	10000	1,2
90 000 000 000 1467	Siyah	3,6	370	100	10000	1,53
90 000 000 000 1468	Siyah	4,8	200	100	10000	1,1
90 000 000 000 1469	Siyah	4,8	250	100	10000	1,39
90 000 000 000 1470	Siyah	4,8	300	100	10000	1,68
90 000 000 000 1471	Siyah	4,8	380	100	5000	1,95
90 000 000 000 1472	Siyah	4,8	400	100	5000	2,25
90 000 000 000 1473	Siyah	7,6	300	100	3000	3,7
90 000 000 000 1474	Siyah	7,6	370	100	3000	3,95
90 000 000 000 1475	Siyah	7,6	400	100	3000	4,5
90 000 000 000 1476	Siyah	7,6	450	100	3000	4,5
90 000 000 000 1477	Siyah	7,6	550	100	3000	5,9
90 000 000 000 1478	Siyah	9	760	100	1000	9,9
90 000 000 000 1479	Siyah	9	920	100	1000	14

■ Dübelli Kablo Bağları

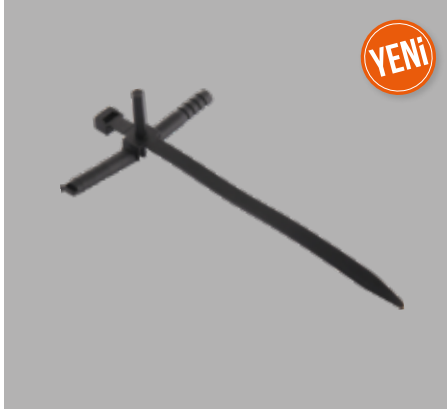

Kod	Ürün Adı	Poşet Ad.	Koli Ad.	Fiyat (₺)
90 000 000 000 1640	9x150 Dübelli Kablo Bağları/Siyah	100	1500	3,7
90 000 000 000 1641	9x200 Dübelli Kablo Bağları/Siyah	100	1500	4,2

HF
HALOGEN
FREE

■ Yapışkan Kroşeler



Kod	Ürün Adı	Poşet Ad.	Koli Ad.	Fiyat (₺)
90 000 000 000 1486	20x20 Yapışkan Kroşe	100	10000	1,4
90 000 000 000 1487	30x30 Yapışkan Kroşe	100	5000	2,2

HF
HALOGEN
FREE

■ Kablo Bağları Etiket Taşıyıcılar

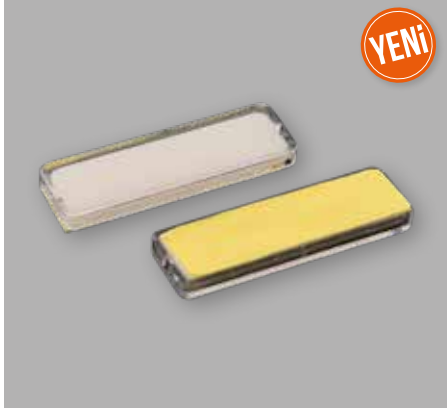

Kod	Ürün Adı	Poşet Ad.	Koli Ad.	Fiyat (₺)
90 000 000 000 1482	10x30 Etiket Taşıyıcı	100	13000	2,4
90 000 000 000 1483	20x40 Etiket Taşıyıcı	100	5000	4,8

HF
HALOGEN
FREE

■ Yapışkanlı Pano Etiketleri



Kod	Ürün Adı	Poşet Ad.	Koli Ad.	Fiyat (₺)
90 000 000 000 1490	13x45 Yapışkanlı Pano Etiketi	100	5000	4,5
90 000 000 000 1491	17x55 Yapışkanlı Pano Etiketi	100	5000	5,7

HF
HALOGEN
FREE

■ Geçmeli Buat Klemensleri



Kod	Ürün Adı	Poşet Ad.	Koli Ad.	Fiyat (\$)
90 000 000 000 1630	2'li Geçmeli Buat Klemensi	100	10000	0,14
90 000 000 000 1631	3'lü Geçmeli Buat Klemensi	100	10000	0,15
90 000 000 000 1632	4'lü Geçmeli Buat Klemensi	100	5000	0,16
90 000 000 000 1633	5'li Geçmeli Buat Klemensi	100	5000	0,18
90 000 000 000 1634	6'li Geçmeli Buat Klemensi	100	5000	0,27
90 000 000 000 1635	8'li Geçmeli Buat Klemensi	100	5000	0,29

■ Mandallı Klemensler



Kod	Ürün Adı	Poşet Ad.	Koli Ad.	Fiyat (\$)
90 000 000 000 1620	2'li Mandallı Klemensi	100	5000	0,28
90 000 000 000 1621	3'lü Mandallı Klemensi	100	5000	0,45
90 000 000 000 1622	5'li Mandallı Klemens	100	5000	0,67

■ Plastik Sıra Klemensler



Kod	Ürün Adı	Poşet Ad.	Koli Ad.	Fiyat (₺)
90 000 000 000 2101	No. 1 Sıra Klemens 2.5-4 mm	50	1000	37,00
90 000 000 000 2102	No. 2 Sıra Klemens 4-6 mm	50	1000	42,00
90 000 000 000 2103	No. 3 Sıra Klemens 10-16 mm	50	500	57,00
90 000 000 000 2104	No. 4 Sıra Klemens 16-25 mm	50	500	69,00
90 000 000 000 2109	No. 5 Sıra Klemens 16-25 mm	50	500	79,00

■ Plastik Sıra Klemensler (Yanmaz)

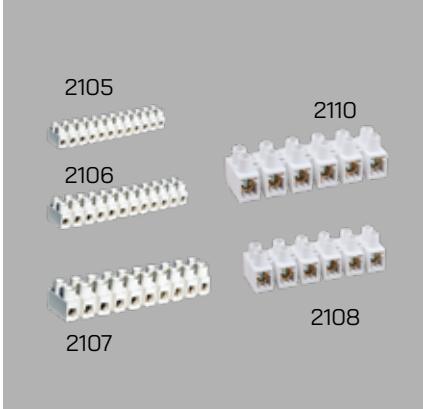

Kod	Ürün Adı	Poşet Ad.	Koli Ad.	Fiyat (₺)
90 000 000 000 2105	No. 1 Yanmaz Sıra Klemens 2.5-4 mm	50	1000	42,00
90 000 000 000 2106	No. 2 Yanmaz Sıra Klemens 4-6 mm	50	1000	46,00
90 000 000 000 2107	No. 3 Yanmaz Sıra Klemens 10-16 mm	50	500	62,00
90 000 000 000 2108	No. 4 Yanmaz Sıra Klemens 16-25 mm	50	500	72,00
90 000 000 000 2110	No. 5 Yanmaz Sıra Klemens 216-25 mm	50	500	89,00



■ Çivili Kroşeler

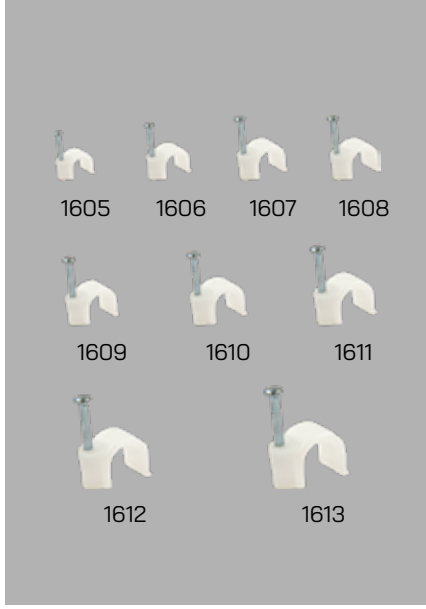

Kod	Ürün Adı	Poşet Ad.	Koli Ad.	Fiyat (₺)
90 000 000 000 1605	No.0 Çivili Kroşe (H:6 mm / D:4,5 mm / N:2x16)	1000	20000	0,45
90 000 000 000 1606	No.1 Çivili Kroşe (H:7 mm / D:4 mm / N:2x16)	1000	20000	0,45
90 000 000 000 1607	No.2 Çivili Kroşe (H:7,5 mm / D:5 mm / N:2x18)	1000	20000	0,45
90 000 000 000 1608	No.3 Çivili Kroşe (H:9,5 mm / D:7 mm / N:2x20)	1000	20000	0,59
90 000 000 000 1609	No.4 Çivili Kroşe (H:10,5 mm / D:8 mm / N:2x21)	1000	20000	0,59
90 000 000 000 1610	No.5 Çivili Kroşe (H:13 mm / D:10 mm / N:2x25)	1000	10000	0,85
90 000 000 000 1611	No.6 Çivili Kroşe (H:15 mm / D:12 mm / N:2x25)	1000	10000	0,85
90 000 000 000 1612	No.7 Çivili Kroşe (H:21 mm / D:18 mm / N:4x10)	100	3000	1,6
90 000 000 000 1613	No.8 Çivili Kroşe (H:25 mm / D:23 mm / N:4x16)	100	2000	2,1

■ Plastik Antigrön Kroşeler



Kod	Ürün Adı	Poşet Ad.	Koli Ad.	Fiyat (₺)
90 000 000 000 1601	Antigrön Kroşe No. 1	100	2000	2,70
90 000 000 000 1602	Antigrön Kroşe No. 1.5	100	2000	2,90
90 000 000 000 1603	Antigrön Kroşe No. 2	100	1000	4,50
90 000 000 000 1604	Antigrön Kroşe No. 3	50	750	8,50

■ Duylar ve Tij Aksamları



Kod	Ürün Adı	Poşet Ad.	Koli Ad.	Fiyat (₺)
90 000 000 000 1406	E - 27 Duylu Askı Tij Takımı (Plastik Duylu)	50	500	45,00
90 000 000 000 1407	E - 27 Duylu Askı Tij Takımı (Porselen Duylu)	50	500	45,00
90 000 000 000 1416	T8 Reklam Duy	100	500	17,50
90 000 000 000 1418	T5 Reklam Duy	100	500	17,50
90 000 000 000 1419	T8 Florasan Duy	50	500	9,00
90 000 000 000 1420	T8 Florasan Duy (Yaylı)	50	500	12,00
90 000 000 000 1421	T8 Florasan Duy (Yatay)	50	500	12,00
90 000 000 000 1422	Kamçı	50	500	0,90
90 000 000 000 1423	Kablo Tutucu	50	500	1,90
90 000 000 000 1424	Mesafe Takoza	50	500	0,95
90 000 000 000 1426	LED PCB Tutucu	1000	10000	0,16
90 000 000 000 1427	Cam Contası	1000	10000	0,17
90 000 000 000 1428	Kablo Çıkış Tapası	1000	10000	0,70



■ Plastik Dübelleri (100'Lük Poşetli Kutulu)

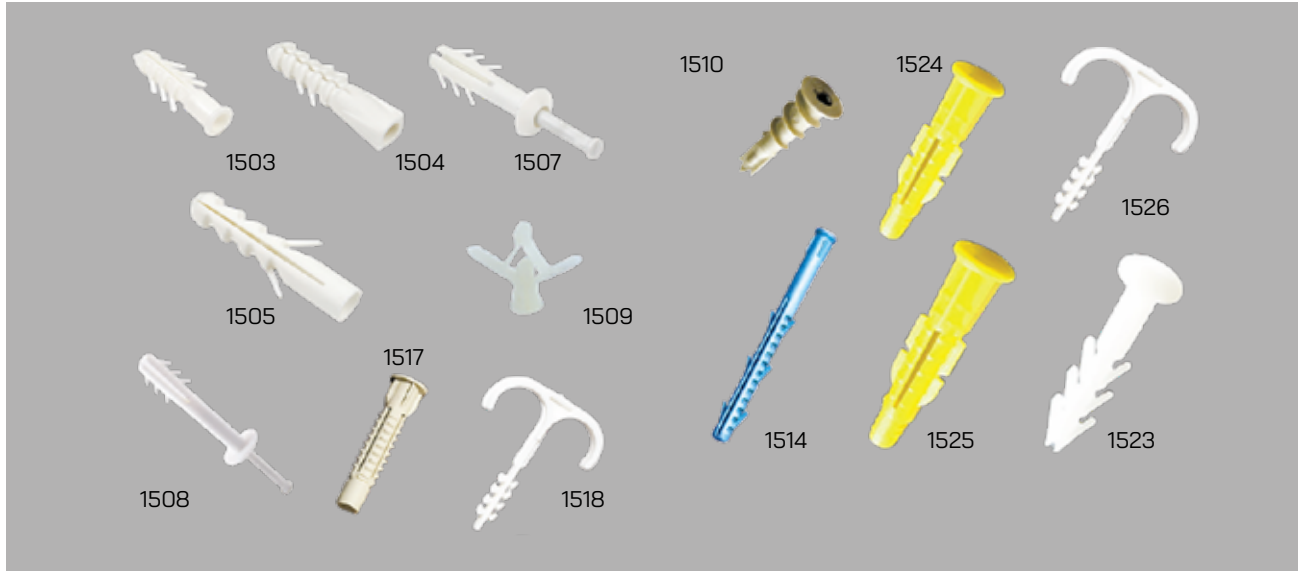

Kod	Ürün Adı	Ambalaj Adedi	Koli Adedi	Fiyat (₺)
90 000 000 000 1501	6 mm Plastik Dübel	100	30000	0,27
90 000 000 000 1502	7 mm Plastik Dübel	100	30000	0,29
90 000 000 000 1503	8 mm Plastik Dübel	100	25000	0,39
90 000 000 001 1503	8 mm Plastik Dübel Köşeli	100	25000	0,49
90 000 000 000 1504	10 mm Plastik Dübel	100	15000	1,10
90 000 000 000 1505	12 mm Plastik Dübel	100	5000	1,50
90 000 000 000 1506	14 mm Plastik Dübel	100	5000	4,50
90 000 000 000 1523	Del-Çak Dübel Dolgulu (Çivisi Çakılı)	100	10000	0,95
90 000 000 000 1507	Plastik Kanal Dübeli	100	10000	0,69
90 000 000 000 1508	Plastik Korniş Dübeli	100	10000	0,89
90 000 000 000 1509	Alçıpan Dübeli (Kelebek)	100	10000	0,85
90 000 000 000 1510	Alçıpan Turbolet Dübel	100	10000	1,10
90 000 000 000 1513	8X60 Kasa ve Çerçeve Dübeli	100	10000	0,72
90 000 000 000 1514	8X80 Kasa ve Çerçeve Dübeli	100	10000	0,74
90 000 000 000 1515	8X100 Kasa ve Çerçeve Dübeli	100	10000	0,75
90 000 000 000 1516	8 mm Tuğla Boşluk Dübeli	100	10000	0,95
90 000 000 000 1517	10 mm Tuğla Boşluk Dübeli	100	10000	1,30
90 000 000 000 1524	Renkli Roket Dübel 8 mm	100	10000	0,79
90 000 000 000 1525	Renkli Roket Dübel 10 mm	100	15000	1,30
90 000 000 000 1518	Kablo Tutucu Dübeli ç 20 mm	250	8000	1,39
90 000 000 000 1526	Kablo Tutucu Dübeli ç 25 mm	250	8000	1,49

■ LED Ampüller



Kod	Ürün Adı	Güç	Kutu Adedi	Koli Adedi	Fiyat (\$)
90 000 000 000 9090	Led Ampul	7W	1	120	1,45
90 000 000 000 9092	Led Ampul	9W	1	120	1,50
90 000 000 000 9093	Led Ampul	12W	1	120	2,30

■ Lillium Duvar Aplik Armatürleri



Kod	Ürün Adı	Güç	Kutu Adedi	Koli Adedi	Fiyat (\$)
22 010 000 001 01960	Beyaz Taban	2XGU10	1	40	4,50
22 010 000 002 01961	Siyah Taban	2XGU10	1	40	4,50

HF
HALOGEN
FREE
IP54

■ LED'li Live Duvar Aplik Armatür



Kod	22 006 001 XXX 03641
Ürün Adı	Led Live Duvar Aplik Armatür / Siyah
Güç	2X3W
Lümen	500
Ambalaj Adedi	1
Koli Adedi	40
Fiyat (\$)	8,50

HF
HALOGEN
FREE
IP54

■ LED 'li Area Duvar ve Tavan Glop Armatürleri



Kod	Ürün Adı	Güç	Lümen	Işık Rengi	Kutu Adedi	Fiyat (\$)
AREA SOFT DUVAR APLİK ARMATÜRLERİ 15W						
22 015 001 300 04395	Beyaz Taban	15W	1500	3000K	1	6,50
22 015 001 650 04396	Beyaz Taban	15W	1500	6500K	1	6,50
22 015 001 300 04397	Siyah Taban	15W	1500	3000K	1	6,50
22 015 001 650 04398	Siyah Taban	15W	1500	6500K	1	6,50
AREA SOFT TAVAN GLOP ARMATÜRLERİ 15W						
22 015 001 300 04430	Beyaz Taban	15W	1500	3000K	1	6,90
22 015 001 650 04431	Beyaz Taban	15W	1500	6500K	1	6,90
22 015 001 300 04432	Siyah Taban	15W	1500	3000K	1	6,90
22 015 001 650 04433	Siyah Taban	15W	1500	6500K	1	6,90
AREA SOFT TAVAN GLOP ARMATÜRLERİ 20W						
22 020 001 300 04434	Beyaz Taban	20W	2100	3000K	1	8,90
22 020 001 650 04435	Beyaz Taban	20W	2100	6500K	1	8,90
22 020 001 300 04436	Siyah Taban	20W	2100	3000K	1	8,90
22 020 001 650 04437	Siyah Taban	20W	2100	6500K	1	8,90

HF
HALOGEN
FREE
IP65

■ Eko Oval Kafesli Duvar Aplik



Kod	22 125 000 001 01931
Ürün Adı	Oval Kafesli (Beyaz)
Duy Tipi	1XE27
Ambalaj Adedi	4
Koli Adedi	48
Fiyat (₺)	114,00

■ Terra Duvar Aplik

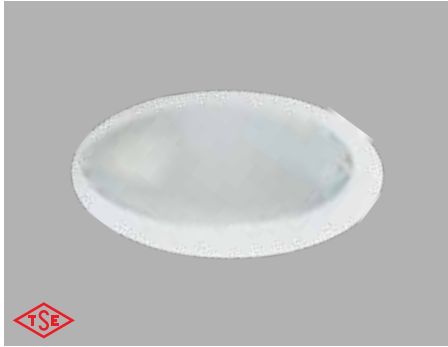

Kod	Ürün Adı	Duy Tipi	Ambalaj Adedi	Koli Adedi	Fiyat (₺)
22 125 000 001 01340	Terra Şeffaf (Beyaz)	1XE27	4	48	95,00
22 125 000 001 01341	Terra Soft (Beyaz)	1XE27	4	48	95,00
22 125 000 xxx 0134X	Terra (Renkli) Taban Farkı				39,00

X -> 0 Terra Şeffaf Renkli / X -> 1 Terra Soft Renkli

■ Gala Kapalı Duvar Aplik

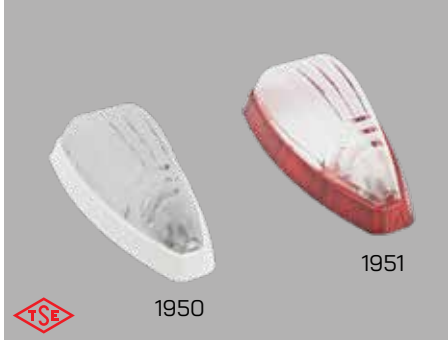

Kod	Ürün Adı	Duy Tipi	Ambalaj Adedi	Koli Adedi	Fiyat (₺)
22 125 000 001 01950	Gala (Beyaz)	1XE27	4	48	95,00
22 125 000 xxx 01951	Gala (Renkli) Taban Farkı				39,00

■ Vera Kapalı Duvar Aplik



Kod	Ürün Adı	Duy Tipi	Ambalaj Adedi	Koli Adedi	Fiyat (₺)
22 125 000 001 01921	Vera (Beyaz)	1XE27	4	48	109,00
22 125 000 xxx 01924	Vera (Renkli) Taban Farkı				39,00

Renk	101 MEŞE	111 MAUN	121 CEVİZ	131 KROM	141 NİKEL	151 ALTIN	161 P.MAVİ	171 FÜME
Kod	101 MEŞE	111 MAUN	121 CEVİZ	131 KROM	141 NİKEL	151 ALTIN	161 P.MAVİ	171 FÜME

■ İlia Duvar Aplik

HF
HÜLİZELEME
FREE
IP20

Kod	Ürün Adı	Duy Tipi	Ambalaj Adedi	Koli Adedi	Fiyat (₺)
22 125 000 001 01952	İlia Aplik (Beyaz)	1XE27	4	48	109,00
22 125 000 xxx 01954	İlia Aplik (Renkli) Taban Farkı				39,00

■ Kapalı Duvar Aplik

HF
HÜLİZELEME
FREE
IP20

Kod	Ürün Adı	Duy Tipi	Ambalaj Adedi	Koli Adedi	Fiyat (₺)
22 125 000 001 01901	Damla (Beyaz)	1XE27	4	48	109,00
22 125 000 001 01902	Papatya (Beyaz)	1XE27	4	48	109,00
22 125 000 xxx 0190X	Damla (Renkli) Taban Farkı				39,00

X -> 1 Damla Şeffaf Renkli / X -> 2 Papatya Soft Renkli

■ İdea Duvar Aplik

HF
HÜLİZELEME
FREE
IP20

Kod	Ürün Adı	Duy Tipi	Ambalaj Adedi	Koli Adedi	Fiyat (₺)
22 125 000 001 01915	İdea Kafessiz (Beyaz)	1XE27	2	24	229,00
22 125 000 001 01916	İdea Kafesli (Beyaz)	1XE27	2	24	239,00
22 125 000 xxx 0191X	İdea (Renkli) Taban Farkı				39,00

X -> 5 Kafessiz / X -> 6 Kafesli

Renk								
Kod	101 MEŞE	111 MAUN	121 CEVİZ	131 KROM	141 NİKEL	151 ALTIN	161 P.MAVİ	171 FÜME



Renkli ürünler için kodlama örneği: 22 125 000 xxx 01142 -> xxx değişkenleri için tercih ettiğiniz rengin kodunu belirtiniz.

Örnek: 22 125 000 101 01142 - İlia Meşe rengini belirtmiş olursunuz.

■ Yarım Ay Açık Duvar Aplik



Kod	Ürün Adı	Duy Tipi	Ambalaj Adedi	Koli Adedi	Fiyat (₺)
20 125 000 001 01911	Riva (Beyaz)	1XE27	4	48	95,00
22 125 000 001 01912	Papatya (Beyaz)	1XE27	4	48	95,00
22 125 000 xxx 0191X	Riva (Renkli) Taban Farkı				39,00
X -> 1 Riva / X -> 2 Papatya					

HF
HALOGEN
FREE

■ Açık Duvar Aplik



Kod	Ürün Adı	Duy Tipi	Ambalaj Adedi	Koli Adedi	Fiyat (₺)
20 125 000 001 01908	Damla (Beyaz)	1XE27	4	48	129,00
20 125 000 001 01909	Papatya (Beyaz)	1XE27	4	48	129,00
20 125 000 001 01910	IVY (Beyaz)	1XE27	4	48	129,00

HF
HALOGEN
FREE

■ Yelken Açık Duvar Aplik

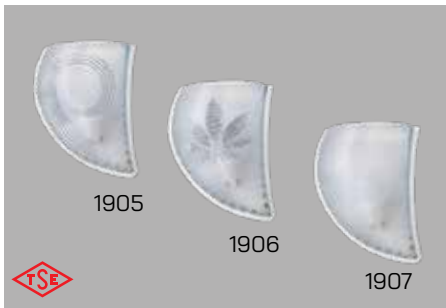

Kod	Ürün Adı	Duy Tipi	Ambalaj Adedi	Koli Adedi	Fiyat (₺)
20 125 000 001 01905	Yelken Ege	1XE27	2	32	135,00
20 125 000 001 01906	Yelken Bahar	1XE27	2	32	135,00
20 125 000 001 01907	Yelken Soft	1XE27	2	32	135,00

HF
HALOGEN
FREE

■ Dekoratif Açık Duvar Aplik

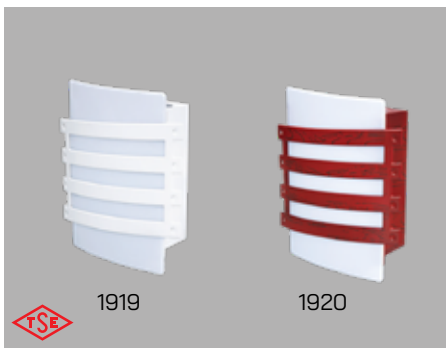

Kod	Ürün Adı	Duy Tipi	Ambalaj Adedi	Koli Adedi	Fiyat (₺)
20 125 000 001 01919	Vista (Beyaz)	1XE27	4	48	109,00
20 125 000 xxx 01920	Vista (Renkli) Taban Farkı				39,00

HF
HALOGEN
FREE

Renk								
Kod	101 MEŞE	111 MAUN	121 CEVİZ	131 KROM	141 NİKEL	151 ALTIN	161 P.MAVİ	171 FÜME



Renkli ürünler için kodlama örneği: 22 125 000 xxx 01142 -> xxx değişkenleri için tercih ettiğiniz rengin kodunu belirtiniz.
Örnek: 22 125 000 101 01142 - İlia Meşe rengini belirtmiş olursunuz.

Dekoratif Eko Glop Armatürleri

HF
HALOGEN
FREE
IP20

Kod	Ürün Adı	Duy Tipi	Ambalaj Adedi	Koli Adedi	Fiyat (₺)
22 115 000 001 01153	Eco Trend (Beyaz)	1XE27	8	64	75,00
22 125 000 xxx 01154	Eco Trend (Renkli) Taban Farkı				39,00

Mini Tavan Glop Armatürleri

HF
HALOGEN
FREE
IP20

Kod	Ürün Adı	Duy Tipi	Ambalaj Adedi	Koli Adedi	Fiyat (₺)
22 125 000 001 01101	Mini Damla (Beyaz)	1XE27	4	48	92,00
22 125 000 001 01106	Mini Papatya (Beyaz)	1XE27	4	48	92,00
22 125 000 001 01109	Mini Riva (Beyaz)	1XE27	4	48	92,00
22 125 000 XXX 0110X	Damla - Papatya - Riva Mini (Renkli) Taban Farkı				39,00

X -> 1 Damla Renkli / X -> 6 Papatya Renkli / X -> 9 Riva Renkli

Büyük Tavan Glop Armatürleri

HF
HALOGEN
FREE
IP20

Kod	Ürün Adı	Duy Tipi	Ambalaj Adedi	Koli Adedi	Fiyat (₺)
22 125 000 001 01102	Papatya (Beyaz)	1XE27	4	48	109,00
22 125 000 001 01105	Damla (Beyaz)	1XE27	4	48	109,00
22 125 000 xxx 0110X	Papatya - Damla (Renkli) Taban Farkı				39,00

X -> 2 Papatya / X -> 5 Damla

Mini Trend Dekoratif Glop Armatürler

HF
HALOGEN
FREE
IP20

Kod	Ürün Adı	Duy Tipi	Ambalaj Adedi	Koli Adedi	Fiyat (₺)
22 125 000 001 01126	Mini Trend (Beyaz)	1XE27	4	48	99,00
22 125 000 001 01134	Mini Trend Soft (Beyaz)	1XE27	4	48	99,00
22 125 000 001 01135	Mini Trend Alya (Beyaz)	1XE27	4	48	99,00
22 125 000 xxx 011XX	Mini Trend (Renkli) Taban Farkı				39,00

XX-26 Şefaf Renkli / XX-34 Soft Renkli / XX-35 Alya Renkli

■ Trend Dekoratif Glop Armatürler

HF
HALLENGEM
FREE IP20



Kod	Ürün Adı	Duy Tipi	Ambalaj Adedi	Koli Adedi	Fiyat (₺)
22 125 000 001 01111	Trend Soft (Beyaz-Siyah)	1XE27	2	24	159,00
22 125 000 001 01112	Trend Şeffaf (Beyaz-Siyah)	1XE27	2	24	159,00
22 125 000 001 01115	Trend Riva (Beyaz-Siyah)	1XE27	2	24	159,00
22 125 000 001 01188	Trend Alya (Beyaz-Siyah)	1XE27	2	24	159,00
22 125 000 xxx 011XX	Trend (Renkli) Taban Farkı				39,00

XX -> 11 Soft / XX -> 12 Şeffaf / XX -> 15 Riva / XX -> 88 Alya

■ Terra Dekoratif Mini Glop Armatür

HF
HALLENGEM
FREE IP20

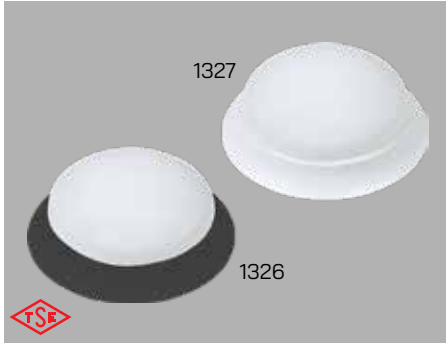

Kod	Ürün Adı	Duy Tipi	Ambalaj Adedi	Koli Adedi	Fiyat (₺)
22 125 000 001 01326	Terra Mini Şeffaf (Beyaz-Siyah)	1XE27	4	48	109,00
22 125 000 001 01327	Terra Mini Soft (Beyaz-Siyah)	1XE27	4	48	109,00
22 125 000 xxx 0132X	Terra Mini (Renkli) Taban Farkı				39,00

X -> 6 Şeffaf / X -> 7 Soft

■ Terra Dekoratif Glop Armatür

HF
HALLENGEM
FREE IP20



Kod	Ürün Adı	Duy Tipi	Ambalaj Adedi	Koli Adedi	Fiyat (₺)
22 125 000 001 01330	Terra Şeffaf (Beyaz-Siyah)	1XE27	2	24	155,00
22 125 000 001 01331	Terra Soft (Beyaz-Siyah)	1XE27	2	24	155,00
22 125 000 xxx 0133X	Terra (Renkli) Taban Farkı				39,00

X -> 0 Şeffaf / X -> 1 Soft

■ Terra Dekoratif Glop Armatür (Çift Duyulu)

HF
HALLENGEM
FREE IP20



Kod	Ürün Adı	Duy Tipi	Ambalaj Adedi	Koli Adedi	Fiyat (₺)
22 225 000 001 01334	Terra Şeffaf (Beyaz-Siyah)	1XE27	2	24	169,00
22 225 000 001 01335	Terra Soft (Beyaz-Siyah)	1XE27	2	24	169,00
22 225 000 xxx 0133X	Terra (Renkli) Taban Farkı				39,00

X -> 4 Şeffaf / X -> 5 Soft

■ İlia Kare Tavan Glop Armatürleri



Kod	Ürün Adı	Duy Tipi	Ambalaj Adedi	Koli Adedi	Fiyat (₺)
22 125 000 001 01140	İlia (Beyaz)	1XE27	1	24	179,00
22 125 000 xxx 01142	İlia (Renkli) Taban Farkı				39,00

■ İlia Mega Kare Tavan Glop Armatürleri (Çift Duyulu)

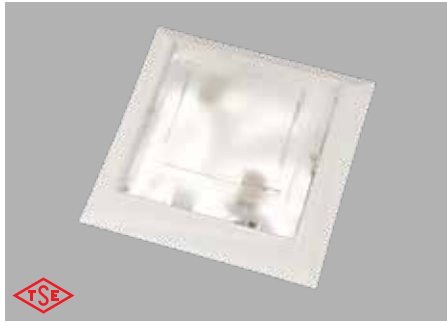
Kod	Ürün Adı	Duy Tipi	Ambalaj Adedi	Koli Adedi	Fiyat (₺)
22 225 000 001 01141	İlia Mega (Beyaz)	2XE27	1	10	365,00
22 225 000 xxx 01143	İlia Mega (Renkli) Taban Farkı				39,00

■ İlia Jumbo Üçgen Tavan Glop Armatürleri (Üç Duyulu)











Kod	Ürün Adı	Duy Tipi	Ambalaj Adedi	Koli Adedi	Fiyat (₺)
22 315 000 001 01144	İlia Jumbo Üçgen (Beyaz)	3XE27	1	10	379,00
22 315 000 xxx 01146	İlia Jumbo Üçgen (Renkli) Taban Farkı				39,00

■ Terra Dekoratif Glop Armatür (Çift Duyulu)



Kod	Ürün Adı	Duy Tipi	Ambalaj Adedi	Koli Adedi	Fiyat (₺)
22 125 000 001 01155	Elit (Beyaz)	1XE27	1	24	199,00
22 125 000 001 01157	Elit Kafesli (Beyaz)	1XE27	1	24	215,00
22 125 000 xxx 0115X	Elit (Renkli) Taban Farkı				39,00
X-5 Elit Renkli / X-7 Elit Kafesli					

Renk								
Kod	101 MEŞE	111 MAUN	121 CEVİZ	131 KROM	141 NİKEL	151 ALTIN	161 P.MAVİ	171 FÜME



Renkli ürünler için kodlama örneği: 22 125 000 xxx 01142 -> xxx değışkenleri için tercih ettiğiniz rengin kodunu belirtiniz.

Örnek: 22 125 000 101 01142 - İlia Meşe rengini belirtmiş olursunuz.

LED'li Trend Alya Soft Tavan Glop Armatürleri



Kod	Ürün Adı	Güç	Ambalaj Adedi	Koli Adedi	Fiyat (\$)
22 024 001 XXX 04439	Beyaz Taban	24W	1	10	21,90
22 024 001 XXX 04441	Siyah Taban	24W	1	10	21,90

XXX -> 300 = 3000 K / XXX -> 400 = 4000 K / XXX -> 650 = 6500 K

LED'li Acil Kitli Trend Alya Soft Tavan Glop Armatürleri



Kod	Ürün Adı	Güç	Ambalaj Adedi	Koli Adedi	Fiyat (\$)
22 024 001 XXX 04445	Beyaz Taban	24W	1	10	31,50
22 024 001 XXX 04447	Siyah Taban	24W	1	10	31,50

XXX -> 300 = 3000 K / XXX -> 400 = 4000 K / XXX -> 650 = 6500 K

LED'li Radar Sensörlü Trend Alya Soft Tavan Glop Armatürleri



Kod	Ürün Adı	Güç	Ambalaj Adedi	Koli Adedi	Fiyat (\$)
22 024 001 XXX 04451	Beyaz Taban	24W	1	10	52,00
22 024 001 XXX 04453	Siyah Taban	24W	1	10	52,00
22 024 xxx XXX 0445X	Renkli Taban Farkı				1,30

XXX -> 300 = 3000 K / XXX -> 400 = 4000 K / XXX -> 650 = 6500 K

LED'li Radar Sensörlü Acil Kit Trend Alya Soft Tavan Glop Armatürleri



Kod	Ürün Adı	Güç	Ambalaj Adedi	Koli Adedi	Fiyat (\$)
22 024 001 XXX 04457	Beyaz Taban	24W	1	10	65,00
22 024 001 XXX 04459	Siyah Taban	24W	1	10	65,00
22 024 xxx XXX 0445X	Renkli Taban Farkı				1,30

XXX -> 300 = 3000 K / XXX -> 400 = 4000 K / XXX -> 650 = 6500 K

X -> 7 Beyaz Taban / X -> 9 Siyah Taban

Renk								
Kod	101 MEŞE	111 MAUN	121 CEVİZ	131 KROM	141 NİKEL	151 ALTIN	161 P.MAVİ	171 FÜME



Renkli ürünler için kodlama örneği: 22 125 000 xxx 01142 -> xxx değişkenleri için tercih ettiğiniz rengin kodunu belirtiniz.

Örnek: 22 125 000 101 01142 - İla Meşe rengini belirtmiş olursunuz.

■ Elegance Nemli Yer Şeffaf Glop Armatürleri (Polikarbon)



Kod	Ürün Adı	Duy Tipi	Ambalaj Adedi	Koli Adedi	Fiyat (₺)
26 125 000 001 01170	Kafessiz Beyaz	1XE27	1	16	315,00
26 125 000 001 01171	Kafesli Beyaz	1XE27	1	16	319,00
26 125 000 001 01172	Şapkalı Beyaz	1XE27	1	16	325,00
26 125 000 003 01173	Kafessiz Gri	1XE27	1	16	315,00
26 125 000 003 01174	Kafesli Gri	1XE27	1	16	319,00
26 125 000 003 01175	Şapkalı Gri	1XE27	1	16	325,00
26 125 000 002 01176	Kafessiz Siyah	1XE27	1	16	315,00
26 125 000 002 01177	Kafesli Siyah	1XE27	1	16	319,00
26 125 000 002 01178	Şapkalı Siyah	1XE27	1	16	325,00

■ Elegance Nemli Yer Soft Glop Armatürleri (Polikarbon)



Kod	Ürün Adı	Duy Tipi	Ambalaj Adedi	Koli Adedi	Fiyat (₺)
26 125 000 001 01179	Kafessiz Beyaz	1XE27	16	30	315,00
26 125 000 001 01180	Kafesli Beyaz	1XE27	16	30	319,00
26 125 000 001 01181	Şapkalı Beyaz	1XE27	16	30	325,00
26 125 000 003 01182	Kafessiz Gri	1XE27	16	30	315,00
26 125 000 003 01183	Kafesli Gri	1XE27	16	30	319,00
26 125 000 003 01184	Şapkalı Gri	1XE27	16	30	325,00
26 125 000 002 01185	Kafessiz Siyah	1XE27	16	30	315,00
26 125 000 002 01186	Kafesli Siyah	1XE27	16	30	319,00
26 125 000 002 01187	Şapkalı Siyah	1XE27	16	30	325,00

■ **360 Derece Hareket Sensörü Armatürler**

HF
HALOGEN
IP40



Kod	Ürün Adı	Ambalaj Adedi	Koli Adedi	Fiyat (\$)
22 000 000 001 01000	Sıva Üstü Hareket Sensörü	1	40	9,30
12 000 000 001 01001	Sıva Altı Hareket Sensörü	1	40	11,20

■ **180 Derece İdea E-27 Duyulu Sensörlü Duvar Aplik**

HF
HALOGEN
IP40



Kod	Ürün Adı	Duy Tipi	Ambalaj Adedi	Koli Adedi	Fiyat (\$)
22 125 000 001 01927	İdea Beyaz	1XE27	1	20	13,00
22 125 000 002 01929	İdea Siyah	1XE27	1	20	13,00
22 125 000 xxx 01928	İdea (Renkli) Taban Farkı				1,30

■ **LED'li İdea Slim 180 Derece Sensörlü Duvar Aplik Armatürleri**

HF
HALOGEN
IP40



Kod	Ürün Adı	Güç	Renk	Ambalaj Adedi	Koli Adedi	Fiyat (\$)
22 010 000 XXX 03612	Beyaz Taban	10W	6500K	1	40	27,50
22 010 000 XXX 03613	Siyah Taban	10W	6500K	1	40	27,50
22 010 000 XXX 03614	İdea (Renkli) Taban Farkı					1,30

XXX -> 300 = 3000 K / XXX -> 400 = 4000 K / XXX -> 650 = 6500 K

■ **LED'li Acil Kitli İdea Slim 180 Derece Sensörlü Duvar Aplik Armatürleri**

HF
HALOGEN
IP65



Kod	Ürün Adı	Güç	Renk	Ambalaj Adedi	Koli Adedi	Fiyat (\$)
22 010 000 XXX 03621	Beyaz Taban	10W	6500K	1	40	37,20
22 010 000 XXX 03622	Siyah Taban	10W	6500K	1	40	37,20
22 010 000 XXX 03623	İdea (Renkli) Taban Farkı					1,30

XXX -> 300 = 3000 K / XXX -> 400 = 4000 K / XXX -> 650 = 6500 K

Renk	101 MEŞE	111 MAUN	121 CEVİZ	131 KROM	141 NİKEL	151 ALTIN	161 P.MAVİ	171 FÜME
Kod	101 MEŞE	111 MAUN	121 CEVİZ	131 KROM	141 NİKEL	151 ALTIN	161 P.MAVİ	171 FÜME



Renkli ürünler için kodlama örneği: 22 125 000 xxx 01142 -> xxx değişkenleri için tercih ettiğiniz rengin kodunu belirtiniz.

Örnek: 22 125 000 101 01142 - İlia Meşe rengini belirtmiş olursunuz.

■ LED'li İdea Slim 180 Derece İkili Sensörlü Duvar Aplik Armatürleri

HF
HALDREM
FREE
IP65

Kod	Ürün Adı	Güç	Renk	Ambalaj Adedi	Koli Adedi	Fiyat (\$)
22 010 000 XXX 03615	Beyaz Taban	10W	6500K	1	40	28,10
22 010 000 XXX 03616	Siyah Taban	10W	6500K	1	40	28,10
22 010 000 XXX 03617	İdea (Renkli) Taban Farkı					1,30
XXX -> 300 = 3000 K / XXX -> 400 = 4000 K / XXX -> 650 = 6500 K						

■ LED'li Acil Kitli İdea Slim 180 Derece İkili Sensörlü Duvar Aplik Armatürleri

HF
HALDREM
FREE
IP65

Kod	Ürün Adı	Güç	Renk	Ambalaj Adedi	Koli Adedi	Fiyat (\$)
22 010 000 XXX 03618	Beyaz Taban	10W	6500K	1	40	37,80
22 010 000 XXX 03619	Siyah Taban	10W	6500K	1	40	37,80
22 010 000 XXX 03620	İdea (Renkli) Taban Farkı					1,30
XXX -> 300 = 3000 K / XXX -> 400 = 4000 K / XXX -> 650 = 6500 K						

■ LED'li İdea Slim 360 Derece Sensörlü Duvar ve Tavan Armatürleri

HF
HALDREM
FREE
IP65

Kod	Ürün Adı	Güç	Renk	Ambalaj Adedi	Koli Adedi	Fiyat (\$)
22 010 000 XXX 03624	Beyaz Taban	10W	6500K	1	40	28,10
22 010 000 XXX 03625	Siyah Taban	10W	6500K	1	40	28,10
22 010 000 XXX 03626	İdea (Renkli) Taban Farkı					1,30
XXX -> 300 = 3000 K / XXX -> 400 = 4000 K / XXX -> 650 = 6500 K						

■ LED'li Acil Kitli İdea Slim 360 Derece Sensörlü Duvar Ve Tavan Aplik Armatürleri

HF
HALDREM
FREE
IP65

Kod	Ürün Adı	Güç	Renk	Ambalaj Adedi	Koli Adedi	Fiyat (\$)
22 010 000 XXX 03627	Beyaz Taban	10W	6500K	1	40	37,80
22 010 000 XXX 03628	Siyah Taban	10W	6500K	1	40	37,80
22 010 000 XXX 03629	İdea (Renkli) Taban Farkı					1,30
XXX -> 300 = 3000 K / XXX -> 400 = 4000 K / XXX -> 650 = 6500 K						

Renk								
Kod	101 MEŞE	111 MAUN	121 CEVİZ	131 KROM	141 NİKEL	151 ALTIN	161 P.MAVİ	171 FÜME



Renkli ürünler için kodlama örneği: 22 125 000 xxx 01142 -> xxx değişkenleri için tercih ettiğiniz rengin kodunu belirtiniz.

Örnek: 22 125 000 101 01142 - İla Meşe rengini belirtmiş olursunuz.

■ Terra 360 Derece Sensörlü Plastik Taban ve Pc Cam Armatürleri



Kod	Ürün Adı	Duy Tipi	Ambalaj Adedi	Koli Adedi	Fiyat (\$)
22 225 000 001 01139	Terra Şeffaf	2XE27	1	10	12,00
22 225 000 001 01339	Terra Soft	2XE27	1	10	12,00
22 225 000 001 01344	Terra Şeffaf Şarjlı (Acilde Led)	2XE27	1	10	21,80
22 225 000 001 01345	Terra Soft Şarjlı (Acilde Led)	2XE27	1	10	21,80
Renkli Ürünler İçin Uygulanacak Liste Fiyat Farkı					1,30

■ LED'li Terra 360 Derece Sensörlü ve Şarjlı Plastik Taban ve Pc Cam Armatürler



Kod	Ürün Adı	Güç	LED	Amb. Ad.	Koli Ad.	Fiyat (\$)
22 020 001 XXX 04483	Terra Şeffaf Ledli	20W	6500K	1	10	14,30
22 020 001 XXX 04484	Terra Soft Ledli	20W	6500K	1	10	14,30
22 020 001 XXX 04485	Terra Şeffaf Ledli Şarjlı	20W	6500K	1	10	22,40
22 020 001 XXX 04486	Terra Soft Ledli Şarjlı	20W	6500K	1	10	22,40
Renkli Ürünler İçin Uygulanacak Liste Fiyat Farkı						29,00
XXX -> 300 = 3000 K / XXX -> 400 = 4000 K / XXX -> 650 = 6500 K						

■ 360 Derece Sensörlü Plastik Taban ve Cam Armatürleri



Kod	Ürün Adı	Duy Tipi	Ambalaj Adedi	Koli Adedi	Fiyat (\$)
22 225 000 001 01120	Comfort Soft	2XE27	1	10	12,80
22 225 000 001 01121	Comfort Şeffaf	2XE27	1	10	12,80
22 225 000 xxx 01122	Comfort Soft (Renkli)	2XE27	1	10	13,70
22 225 000 xxx 01123	Comfort Şeffaf (Renkli)	2XE27	1	10	13,70
22 225 000 001 01128	Oval Vizyon	2XE27	1	10	13,00
22 225 000 xxx 01129	Oval Vizyon (Renkli)	2XE27	1	10	14,30

Renk	101 MEŞE	111 MAUN	121 CEVİZ	131 KROM	141 NİKEL	151 ALTIN	161 P.MAVİ	171 FÜME
Kod	101 MEŞE	111 MAUN	121 CEVİZ	131 KROM	141 NİKEL	151 ALTIN	161 P.MAVİ	171 FÜME



Renkli ürünler için kodlama örneği: 22 125 000 xxx 01142 -> xxx değişkenleri için tercih ettiğiniz rengin kodunu belirtiniz.
Örnek: 22 125 000 101 01142 - İlia Meşe rengini belirtmiş olursunuz.

■ Trend 360 Derece Sensörlü Sac Taban ve Pc Cam Armatürleri

HF
HALODREN
EPECE IP40

Kod	Ürün Adı	Duy Tipi	Ambalaj Adedi	Koli Adedi	Fiyat (\$)
22 225 000 XXX 04479	Trend Şeffaf	2XE27	1	10	14,60
22 225 000 XXX 04480	Trend Soft	2XE27	1	10	14,60
22 225 000 XXX 04481	Trend Şeffaf Şarjlı (Acilde Led)	2XE27	1	10	24,60
22 225 000 XXX 04482	Trend Soft Şarjlı (Acilde Led)	2XE27	1	10	24,60

■ LED'li Trend 360 Derece Sensörlü Sac Taban ve Pc Cam ve Şarjlı Tavan Armatürler

HF
HALODREN
EPECE IP40

Kod	Ürün Adı	Led	Ambalaj Adedi	Koli Adedi	Fiyat (\$)
22 020 001 XXX 04477	Trend Şeffaf Ledli	6500K	1	10	17,10
22 020 001 XXX 01138	Trend Soft Ledli	6500K	1	10	17,10
22 020 001 XXX 04478	Trend Şeffaf Ledli Şarjlı	6500K	1	10	25,30
22 020 001 XXX 01203	Trend Soft Ledli Şarjlı	6500K	1	10	25,30

■ Trend Plus 360 Derece Sensörlü Sac Taban ve Cam Tavan Armatürleri

HF
HALODREN
EPECE IP40

Kod	Ürün Adı	Güç	Duy Tipi	Ambalaj Adedi	Koli Adedi	Fiyat (\$)
22 225 000 XXX 01130	Trend	20W	2XE27	1	10	15,00
22 225 000 XXX 01145	Trend Şarjlı (Acilde Led)	20W	2XE27	1	10	25,00

■ LED'li Trend Plus 360 Derece Sensörlü Sac Taban ve Cam Şarjlı Tavan Armatürleri

HF
HALODREN
EPECE IP40

Kod	Ürün Adı	Güç	Led	Amb. Ad.	Koli Ad.	Fiyat (\$)
22 024 001 XXX 01131	Trend Led'li	20W	6500K	1	10	17,40
22 024 001 XXX 01132	Trend Led'li / Şarjlı (Acilde Led)	20W	6500K	1	10	25,60

■ LED'li Slim Trend Plus 360 Derece Sensörlü Sac Taban, Pls. Şeffaf Camlı ve Şarjlı Tavan Armatürleri

HF
HALODREN
EPECE IP40

Kod	Ürün Adı	Güç	Led	Amb. Ad.	Koli Ad.	Fiyat (\$)
22 020 000 XXX 04473	Slim Trend Led'li Şeffaf	20W	6500K	1	20	18,00
22 020 000 XXX 04475	Slim Trend Led'li Şeffaf Şarjlı (Acilde Led)	20W	6500K	1	20	25,90

■ LED'li Slim Trend Plus 360 Derece Sensörlü Sac Taban, Pls. Soft Camlı ve Şarjlı Tavan Armatürleri

HF
HALODREN
EPECE IP40

Kod	Ürün Adı	Güç	Led	Amb. Ad.	Koli Ad.	Fiyat (\$)
22 020 000 XXX 04474	Slim Trend Led'li Soft	20W	6500K	1	20	18,00
22 020 000 XXX 04476	Slim Trend Led'li Soft Şarjlı (Acilde Led)	20W	6500K	1	20	25,90

XXX -> 300 = 3000 K / XXX -> 400 = 4000 K / XXX -> 650 = 6500 K

■ **LED**'li 8W Acil Aydınlatma Armatürü (Kitli)

HF
HALODRUM
FREE
IP44



1-3 SAAT
ÇALIŞMA
SÜRESİ

Kod	Ürün Adı	Güç	Renk	Ambalaj Adedi	Koli Adedi	Fiyat (\$)
32 008 001 650 08022	8W Ledli Acil Aydınlatma Arm (Kitli 36 Ledli)	8W	6500K	1	40	43,70

■ **LED**'li 8W Acil Çıkış Yönlendirme Armatürler (Kitli)

HF
HALODRUM
FREE
IP44



1-3 SAAT
ÇALIŞMA
SÜRESİ



Kod	Ürün Adı	Güç	Renk	Amb. Ad.	Koli Ad.	Fiyat (\$)
32 008 001 650 080xx	8W Ledli Acil Çıkış Yönlendirme Arm (Kitli 36 Ledli)	8W	6500K	1	40	45,30
32 008 001 650 080xx	8W Ledli Acil Çıkış Yönlendirme Arm (Özel Yön Etiketli)	8W	6500K	1	40	46,50

■ **LED**'li 8W Acil Çıkış Yönlendirme Armatürleri

HF
HALODRUM
FREE
IP20



SIVA ALTI
APARATI



Kod	Ürün Adı	Güç	Renk	Amb. Ad.	Koli Ad.	Fiyat (\$)
32 008 001 650 08000	8W Exit Acil Yönlendirme Tavan - Duvara Montaj	8W	6500K	2	24	33,70
32 008 001 650 08100	8W Exit Acil Yönlendirme Zincirle Montaj	8W	6500K	2	24	33,70
32 008 001 650 08xxx	8W Exit Acil Yönlendirme Özel Yön Etiketli	8W	6500K	2	24	35,00
32 000 000 000 08020	Acil Durum Yönlendirme Siva Altı Aparatı	8W	Beyaz	1	-	7,50

■ **LED'li U Tipi Etanj Armatürleri**

HF HALBEN FREI IP54



Kod	Ürün Adı	Kasa Ölçüsü	Güç	Lümen	Ambalaj Adedi	Koli Adedi	Fiyat (\$)
25 020 001 XXX 04206	Ledli U1 Eko Etanj Arm.	60 cm	20W	1300	1	6	28,80
25 040 001 XXX 04208	Ledli U1 Eko Etanj Arm.	120 cm	40W	2800	1	4	35,00

■ **LED'li Plus Tipi Etanj Armatürler**

HF HALBEN FREI IP54



Kod	Ürün Adı	Kasa Ölçüsü	Güç	Lümen	Ambalaj Adedi	Koli Adedi	Fiyat (\$)
25 020 001 XXX 04056	Ledli U1 Etanj Arm.	60 cm	20W	2050	1	6	39,00
25 040 001 XXX 04058	Ledli U1 Etanj Arm.	60 cm	40W	4100	1	6	45,00
25 040 001 XXX 04203	Ledli U1 Etanj Arm.	120 cm	40W	4100	1	4	45,00
24 050 001 XXX 04060	Ledli U1 Etanj Arm.	120 cm	50W	6100	1	4	75,00

■ **LED'li Aliminyum Etanj Armatürleri**

HF HALBEN FREI IP54



Kod	Ürün Adı	Kasa Ölçüsü	Güç	Lümen	Ambalaj Adedi	Koli Adedi	Fiyat (\$)
25 020 001 xxx 04240	Ledli Aliminyum Etanj Arm.	60cm	20W	2400	1		61,00
25 027 001 xxx 04241	Ledli Aliminyum Etanj Arm.	60cm	27W	3350	1		63,00
25 040 001 xxx 04242	Ledli Aliminyum Etanj Arm.	120cm	40W	4800	1		65,00
25 054 001 xxx 04243	Ledli Aliminyum Etanj Arm.	120cm	54W	6700	1		67,00

XXX -> 300 = 3000 K / XXX -> 400 = 4000 K / XXX -> 650 = 6500 K

■ T8 Led Tüp Tms Armatürler (Elektronik Balastlı)

HF IP20



Kod	Ürün Adı	Güç	Ampül	Ambalaj Adedi	Koli Adedi	Fiyat (₺)
22 110 000 001 01391	T8 Tms Bant Arm.	1X10W	LED	6	6	259,00
22 210 000 001 01392	T8 Tms Bant Arm.	2X10W	LED	6	6	285,00
22 120 000 001 01393	T8 Tms Bant Arm.	1X20W	LED	6	6	355,00
22 220 000 001 01394	T8 Tms Bant Arm.	2X20W	LED	6	6	399,00

■ T8 Tms Armatürler (Elektronik Balastlı)

HF IP20



Kod	Ürün Adı	Güç	Ampül	Ambalaj Adedi	Koli Adedi	Fiyat (₺)
22 118 003 001 09300	T8 Tms Bant Arm.	1X18W	T26	6	6	479,00
22 218 003 001 09301	T8 Tms Bant Arm.	2X18W	T26	6	6	512,00
22 136 003 001 09302	T8 Tms Bant Arm.	1X36W	T26	6	6	562,00
22 236 003 001 09303	T8 Tms Bant Arm.	2X36W	T26	6	6	615,00

■ Etanj Duylu T8 Led Tüp İçin Tms Armatürler

HF IP54



Kod	Ürün Adı	Güç	Ampül	Ambalaj Adedi	Koli Adedi	Fiyat (₺)
22 110 000 001 01395	T8 Tms Bant Arm.	1X10W	LED	6	6	512,00
22 210 000 001 01396	T8 Tms Bant Arm.	2X10W	LED	6	6	819,00
22 120 000 001 01397	T8 Tms Bant Arm.	1X20W	LED	6	6	615,00
22 220 000 001 01398	T8 Tms Bant Arm.	2X20W	LED	6	6	923,00
22 120 000 001 01399	T8 Tms Bant Arm.	1X20W	LED	6	6	667,00
22 220 000 001 01400	T8 Tms Bant Arm.	2X20W	LED	6	6	975,00

■ T8 Etanj Duylu Tms Armatürler (Elektronik Balastlı)

HF IP20



Kod	Ürün Adı	Güç	Ampül	Ambalaj Adedi	Koli Adedi	Fiyat (₺)
22 118 003 001 03282	T8 Tms Bant Arm.	1X18W	T26	2	12	907,00
22 218 003 001 03283	T8 Tms Bant Arm.	2X18W	T26	2	12	1.235,00
22 136 003 001 03284	T8 Tms Bant Arm.	1X36W	T26	2	8	1.009,00
22 236 003 001 03285	T8 Tms Bant Arm.	2X36W	T26	2	8	1.335,00
22 158 003 001 03286	T8 Tms Bant Arm.	1X58W	T26	2	6	1.369,00
22 258 003 001 03287	T8 Tms Bant Arm.	2X58W	T26	2	6	1.522,00

■ YENİ LED'li Orkide Bant Armatürler

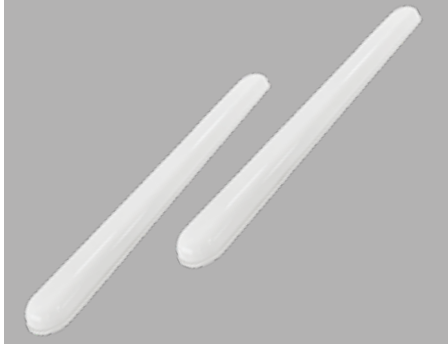
HF
IP40

Kod	22 020 001 XXX 04074
Ürün Adı	Ledli Orkide Bant Arm
Kasa Ölçüsü	60 cm
Güç	20W
Lümen	1600
Ambalaj Adedi	1
Koli Adedi	20
Fiyat (\$)	14,00

■ LED'li Oval Camlı Bant Armatürler

HF
IP40

Kod	Ürün Adı	Kasa Ölçüsü	Lümen	Ampül	Amb. Ad.	Koli Ad.	Fiyat (\$)
22 010 001 XXX 04024	Oval Camlı Bant Arm.	30 cm	900	10W	1	20	19,00
22 020 001 XXX 04026	Oval Camlı Bant Arm.	60 cm	1600	20W	1	20	21,00
22 040 001 XXX 04030	Oval Camlı Bant Arm.	120 cm	3000	40W	1	20	41,00
22 0XX 001 XXX 04076	ON-OFF Anahtar Dahil Montaj Fiyat Farkı						2,50
XX -> 09 - 9W ON OFF DÜĞMELİ / XX -> 18 - 18W ON OFF DÜĞMELİ / XX -> 36 - 36W ON OFF DÜĞMELİ							

■ LED'li Tezgah Altı Bant Armatürler

HF
IP40

Kod	Ürün Adı / Kasa Ölçüsü	Güç	Amb. Adedi	Koli Adedi	Fiyat (\$)
22 010 001 XXX 04315	30 cm	10W	1	-	32,00
22 010 001 XXX 04317	30 cm Anahtarlı	10W	1	-	34,00
22 010 001 XXX 04319	30 cm Anahtarlı+1 Priz	10W	1	-	36,00
22 010 001 XXX 04321	30 cm Anahtarlı+2 Priz	10W	1	-	38,00
22 020 001 XXX 04323	60 cm	20W	1	-	51,00
22 020 001 XXX 04325	60 cm Anahtarlı	20W	1	-	53,00
22 020 001 XXX 04327	60 cm Anahtarlı+1 Priz	20W	1	-	55,00
22 020 001 XXX 04329	60 cm Anahtarlı+2 Priz	20W	1	-	57,00

■ 85x65 Nova Alüminyum Gövde LED'li Lineer Armatürler

HF
IP40

Kod	Ürün Adı	Kasa Ölçüsü	Güç	Lümen	Amb. Ad.	Koli Ad.	Fiyat (\$)
24 020 001 XXX 04068	Alm. Gövde Ledli Lineer Arm.	60cm	20W	2050	1	4	65,00
24 040 001 XXX 04070	Alm. Gövde Ledli Lineer Arm.	120cm	40W	4100	1	4	93,00
24 050 001 XXX 04072	Alm. Gövde Ledli Lineer Arm.	150cm	50W	5125	1	4	139,00
90 000 000 000 9049	150 cm Askı Aparatı				2	Tk.	7,00

XXX -> 300 = 3000 K / XXX -> 400 = 4000 K / XXX -> 650 = 6500 K

■ Polikarbon Gövde Clip-In E-27 Duylu Armatürler 300x300x60

HF HALOGEN FREE IP40



Kod	Ürün Adı	Ambalaj Adedi	Koli Adedi	Fiyat (₺)
12 225 000 001 07146	2XE-27 Duylu Prizmatik Lensli	4	24	365,00
12 225 000 001 07147	2XE-27 Duylu Opal Lensli	4	24	365,00

■ Plus Model 2xE-27 Duylu Clip-In Armatürler 300x300x60

HF HALOGEN FREE IP40

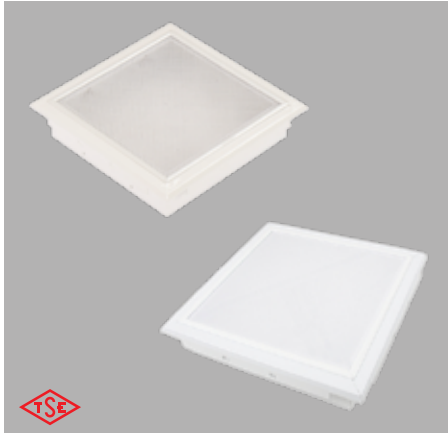

Kod	Ürün Adı	Ambalaj Adedi	Koli Adedi	Fiyat (₺)
12 225 000 001 03221	2XE-27 Duylu Prizmatik Lensli	4	24	509,00
12 225 000 001 03222	2XE-27 Duylu Opal Lensli	4	24	509,00

■ LED'li EKO Siva Altı Slim Backlight Armatürler

HF HALOGEN FREE IP40



Kod	Ürün Adı	Kasa Ölçüsü	Güç	Lümen	Ambalaj Adedi	Koli Adedi	Fiyat (\$)
12 040 001 XXX 04139	Eko Siva Altı Slim Backlight Arm.	60X60	40W	2800	-	10	35,00

METAL (CLIP-IN) TAVAN ARMATÜR FARKI

-

ALÇIPAN TAVAN ARMATÜR FARKI

-

• Gövde: DKP sac • Difüzör: Prizmatik Lensli ve Opal Lensli • Gövde Rengi: RAL 9016 elektrostatik toz boyalı • Driver: ENEC Sabit akım çıkışlı, yüksek verimli PF > 0,95

XXX -> 650 = 6500 K

LED'li Siva Altı Slim Backlight Armatürler



Kod	Ürün Adı	Kasa Ölçüsü	Güç	Lümen	Amb. Ad.	Koli Ad.	Fiyat (\$)
12 040 001 XXX 04004	Siva Altı Slim Backlight Arm.	60X60	40W	2800	2	6	49,50
12 040 001 XXX 04003	Siva Altı Slim Backlight Arm.	30X120	40W	2800	2	4	55,00
12 080 001 XXX 04224	Siva Altı Slim Backlight Arm.	60X120	80W	5600	2	2	121,00
METAL (CLIP-IN) TAVAN ARMATÜR FARKI							-
ALÇIPAN TAVAN ARMATÜR FARKI							-
• Gövde: DKP sac • Difüzör: Prizmatik Lensli ve Opal Lensli • Gövde Rengi: RAL 9016 elektrostatik toz boyalı • Driver: ENEC Sabit akım çıkışlı, yüksek verimli PF > 0,95							

LED'li Siva Üstü Slim Backlight Armatürler



Kod	Ürün Adı	Kasa Ölçüsü	Güç	Lümen	Amb. Ad.	Koli Ad.	Fiyat (\$)
24 040 001 XXX 04122	Siva Üstü Slim Backlight Arm.	60X60	40W	2200	2	6	52,50
24 040 001 XXX 04123	Siva Üstü Slim Backlight Arm.	30X120	40W	2200	2	4	58,00
24 080 001 XXX 04226	Siva Üstü Slim Backlight Arm.	60X120	80W	4600	2	2	127,00
• Gövde: DKP sac • Difüzör: Prizmatik Lensli ve Opal Lensli • Gövde Rengi: RAL 9016 elektrostatik toz boyalı • Driver: ENEC Sabit akım çıkışlı, yüksek verimli PF > 0,95							

LED'li Siva Altı Slim Plus Backlight Armatürler



Kod	Ürün Adı	Kasa Ölçüsü	Güç	Lümen	Amb. Ad.	Koli Ad.	Fiyat (\$)
12 040 001 XXX 04138	Siva Altı Slim Backlight Arm.	60X60	40W	2800	2	6	55,00
12 040 001 XXX 04140	Siva Altı Slim Backlight Arm.	30X120	40W	2800	2	4	61,00
12 080 001 XXX 04228	Siva Altı Slim Backlight Arm.	60X120	80W	5600	2	2	132,00
METAL (CLIP-IN) TAVAN ARMATÜR FARKI							-
ALÇIPAN TAVAN ARMATÜR FARKI							-
• Gövde: DKP sac • Difüzör: Prizmatik Lensli ve Opal Lensli • Gövde Rengi: RAL 9016 elektrostatik toz boyalı • Driver: ENEC Sabit akım çıkışlı, yüksek verimli PF > 0,95							

LED'li Siva Üstü Slim Plus Backlight Armatürler



Kod	Ürün Adı	Kasa Ölçüsü	Güç	Lümen	Amb. Ad.	Koli Ad.	Fiyat (\$)
24 040 001 XXX 04191	Siva Üstü Slim Backlight Arm.	60X60	40W	2800	2	6	58,00
24 040 001 XXX 04193	Siva Üstü Slim Backlight Arm.	30X120	40W	2800	2	4	64,00
24 080 001 XXX 04230	Siva Üstü Slim Backlight Arm.	60X120	80W	5600	2	2	138,00
• Gövde: DKP sac • Difüzör: Prizmatik Lensli ve Opal Lensli • Gövde Rengi: RAL 9016 elektrostatik toz boyalı • Driver: ENEC Sabit akım çıkışlı, yüksek verimli PF > 0,95							

XXX -> 300 = 3000 K / XXX -> 400 = 4000 K / XXX -> 650 = 6500 K

■ Plastik Sıva Üstü Slim Led Panel Çerçeveleri



Kod	Ürün Adı	Cinsi	Dış Ölçü	İç Ölçü	Koli Ad.	Fiyat (₺)
90 000 000 000 9053	Sıva Üstü Led Panel Arm Çerçeve	12w Led Panel İçi	221X40 mm	174 mm	80	33,00
90 000 000 000 9054	Sıva Üstü Led Panel Arm Çerçeve	18w Led Panel İçi	272X40 mm	225 mm	36	55,00
90 000 000 000 9055	Sıva Üstü Led Panel Arm Çerçeve	24w Led Panel İçi	350X40 mm	303 mm	24	85,00
Renk Farkı						39,00

■ Demonte Sıva Üstü Slim Led Panel Armatür Çerçeveleri



Kod	90 000 000 000 9083
Ürün Adı	Sıva Üstü Slim Led Panel Arm Çerçeveleri
Kasa Ölçüsü	600X600X45
Ambalaj Adedi	1
Koli Adedi	15
Fiyat (₺)	199,00

■ Sıva Üstü Slim Led Panel Armatür Çerçeveleri

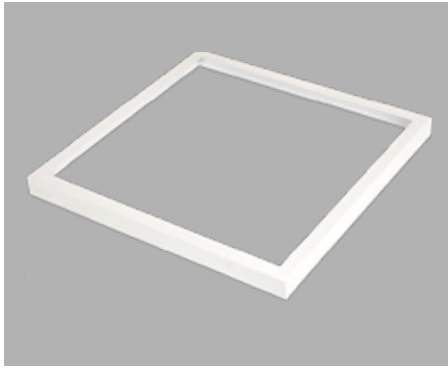

Kod	Ürün Adı	Kasa Ölçüsü	Ambalaj Adedi	Koli Adedi	Fiyat (₺)
90 000 000 000 9087	Sıva Üstü Led Panel Arm Çerçeve	300X300X45	1	50	389,00
90 000 000 000 9086	Sıva Üstü Led Panel Arm Çerçeve	300X600X45	1	25	399,00
90 000 000 000 9085	Sıva Üstü Led Panel Arm Çerçeve	600X600X45	1	25	409,00

■ Sıva Üstü Plus Slim Led Panel Armatür Çerçeveleri

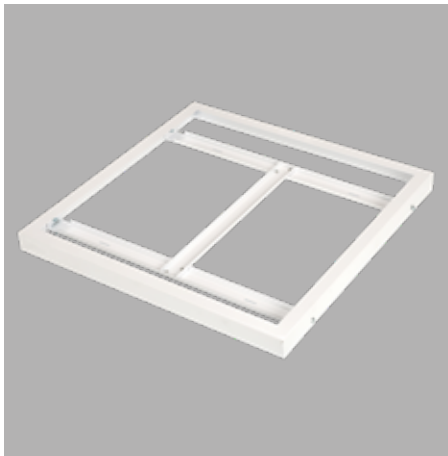

Kod	Ürün Adı	Kasa Ölçüsü	Ambalaj Adedi	Koli Adedi	Fiyat (₺)
90 000 000 000 9041	Sıva Üstü Slim Led Panel Arm Çerçeve	300X300X45	1	40	749,00
90 000 000 000 9042	Sıva Üstü Slim Led Panel Arm Çerçeve	300X600X45	1	20	765,00
90 000 000 000 9044	Sıva Üstü Slim Led Panel Arm Çerçeve	600X600X45	1	10	785,00
90 000 000 000 9012	Sıva Üstü Slim Led Panel Arm Çerçeve	300X1200X45	1	10	885,00

İSİLDAR
LIGHTING SYSTEM

İSİLDAR PLASTİK VE AYDINLATMA A.Ş.
İkitelli Organize Sanayi Bölgesi İpkas Sanayi Sit.
3. Etap B Blok No: 9 İkitelli / İstanbul - TURKEY
T: +90 212 549 53 93 • F: +90 212 549 53 96
www.isildar.eu • info@isildaraydinlatma.com

